

# BOREAS LED UFO HIGH BAY LIGHT



## 60W-500W Full Range UFO High Bay Light



150lm/W  
170lm/W  
190lm/W

IP65

IK08

Warranty

CCT Selectable

Power Selectable

Microwave sensor

Zhaga

High Brightness Lumileds LED Chips

- 1. CCT: 2700K/3000K/4000K/5000K/5700K/6500K
- 2. Lumen Efficiency: 150lm/W, 170lm/W, 190lm/W
- 3. CRI: Ra>80
- 4. Lifetime: 50,000Hrs@L70

PHILIPS or SOSEN Driver

**PHILIPS** DRIVER  
**SOSEN** DRIVER

3 CCT & Power & Beam  
Angle Switchable

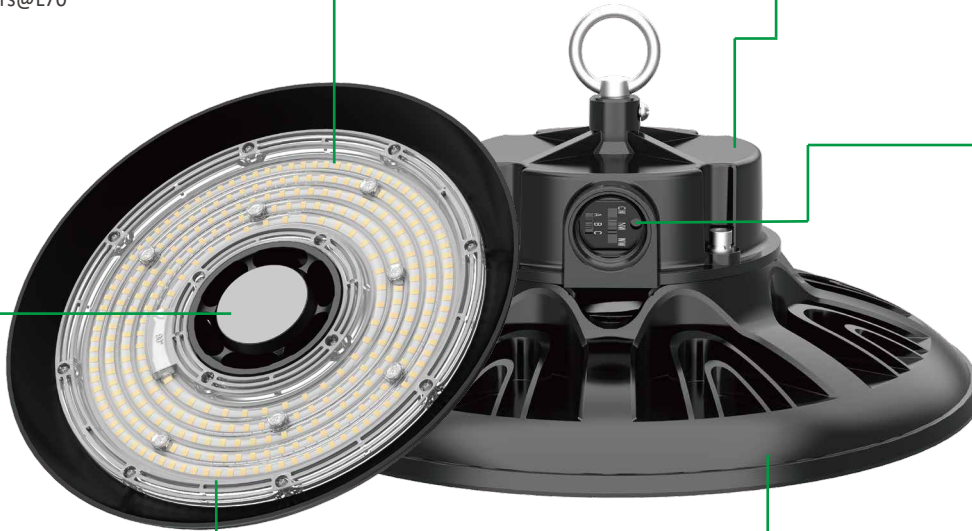

For ZHAGA or Sensor

- 1. Zhaga Socket
- 2. Microwave Sensor

High Strength Polycarbonate Lens

- 1. Beam angle options : 60/90/120°
- 2. IK 08

Aluminum Housing

Die-cast technology with ADC12  
excellent thermal management

## 150lm/W CRI>80, and 170lm/W, 190lm/W Options



60W



100W



150W



200W/240W



300W



400W/500W

# CCT & POWER & Beam Angle Adjustable

| A    | B    | C    |
|------|------|------|
| 100W | 80W  | 60W  |
| 150W | 120W | 100W |
| 200W | 150W | 100W |
| 240W | 200W | 150W |
| 300W | 240W | 200W |
| 500W | 400W | 300W |

| WW    | NW    | CW    |
|-------|-------|-------|
| 4000K | 5000K | 5700K |

| Beam Angle |     |      |
|------------|-----|------|
| 60°        | 90° | 120° |

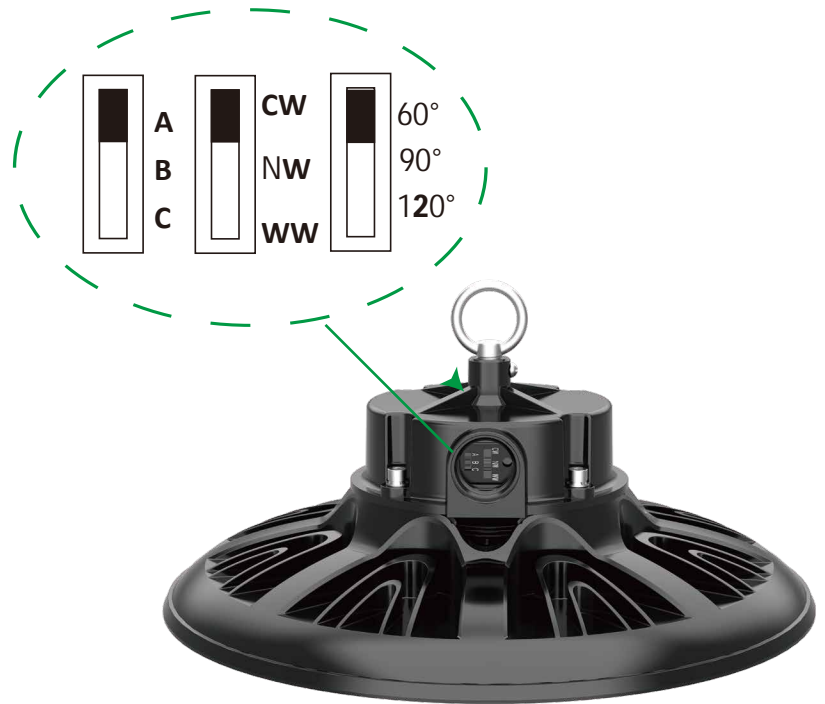

## Specifications

| Model No            | LGS-UFOB-60W                                     | LGS-UFOB-100W  | LGS-UFOB-150W | LGS-UFOB-200W | LGS-UFOB-240W | LGS-UFOB-300W | LGS-UFOB-400W   | LGS-UFOB-500W   |
|---------------------|--|----------------|---------------|---------------|---------------|---------------|-----------------|-----------------|
| Power               | 60W  | 100W           | 150W          | 200W          | 240W          | 300W          | 400W            | 500W            |
| Input Voltage       | AC100-277V,50/60HZ                               |                |               |               |               |               |                 |                 |
| Lumen EFF.          | 150lm/W,170lm/W,190lm/W                          |                |               |               |               |               |                 |                 |
| Lumen Flux(±5%)     | 9,000LM  | 15,000LM       | 22,500LM      | 30,000LM      | 36,000LM      | 45,000LM      | 60,000LM        | 75,000LM        |
|                     | 10,200LM   | 17,000LM       | 25,500LM      | 34,000LM      | 40,800LM      | 51,000LM      | 68,000LM        | 85,000LM        |
|                     | 11,400LM   | 19,000LM       | 28,500LM      | 38,000LM      | 45,600LM      | 57,000LM      | 76,000LM        | 95,000LM        |
| QTY of LEDs         | 130PCS/ 172PCS                                   | 208PCS/300 PCS | 300PCS/450PCS | 420PCS/680PCS | 420PCS/680PCS | 616PCS/935PCS | 1100PCS/1530PCS | 1100PCS/1530PCS |
| LED Brand           | LUMILEDS 2835 /SAN'AN 2835                       |                |               |               |               |               |                 |                 |
| Driver Brand        | SOSEN or PHILIPS                                 |                |               |               |               |               | MOSO            |                 |
| CCT                 | 2700K,3000K,4000K,5000K,5700K,6500K and 3CCT ADJ |                |               |               |               |               |                 |                 |
| CRI                 | >80(>90 available on request)                    |                |               |               |               |               |                 |                 |
| PF                  | >0.95  |                |               |               |               |               |                 |                 |
| Beam Angle          | 60°/90°/120°                                     |                |               |               |               |               | 40°/60°/90°     |                 |
| Protection          | IP65 & IK08                                      |                |               |               |               |               |                 |                 |
| Surge Protection    | 6KV  |                |               |               |               |               |                 |                 |
| Warranty            | 5-year@SOSEN & MOSO, 7-year@PHILIPS              |                |               |               |               |               |                 |                 |
| Dimmension(mm)      | 233*145  | 260*145        | 287*147       | 305*149       | 305*149       | 342*168       | 447*178         | 447*178         |
| SDCM                | <5   |                |               |               |               |               |                 |                 |
| Light Decay Rate    | Less than 3% in 9,000Hours                       |                |               |               |               |               |                 |                 |
| THD                 | <15%   |                |               |               |               |               |                 |                 |
| Start Time          | ≤0.1s  |                |               |               |               |               |                 |                 |
| Class of Insulation | Class I  |                |               |               |               |               |                 |                 |
| Working Tem.        | -30 ~+45 , 10%-90%R.H.                           |                |               |               |               |               |                 |                 |

# Photometry

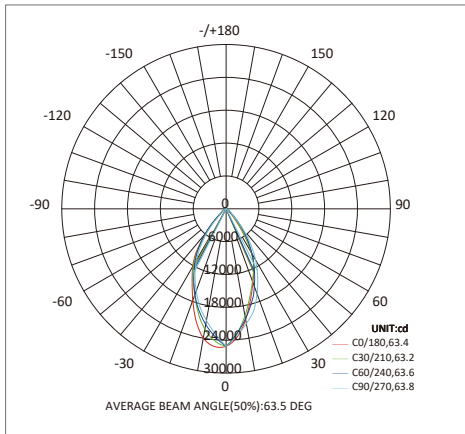
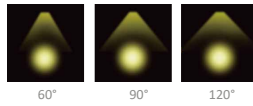

60°

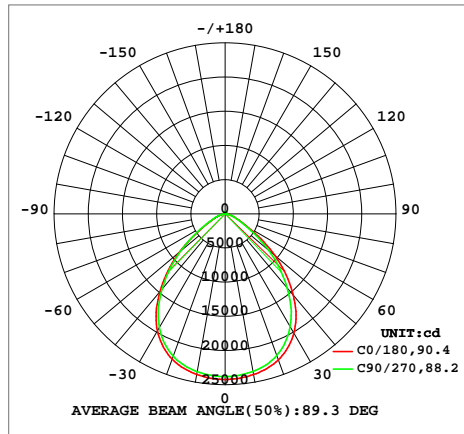

90°

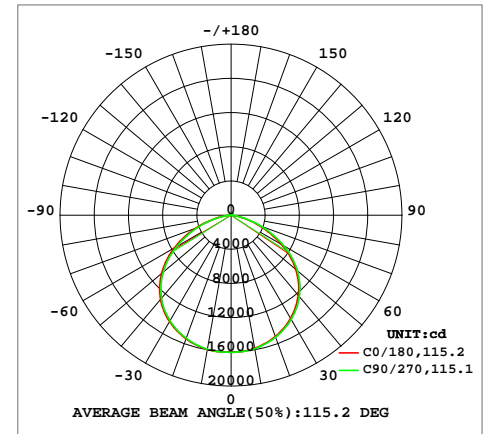

120°

# Dimensions

01 LGS-UFOB-60W

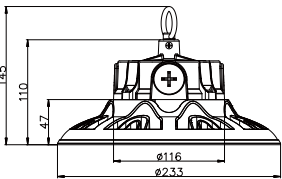

02 LGS-UFOB-100W

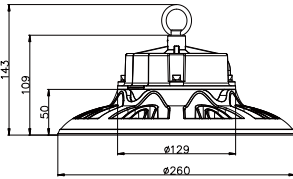

03 LGS-UFOB-150W

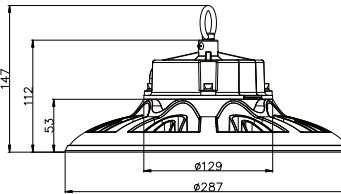

04 LGS-UFOB-200W/240W

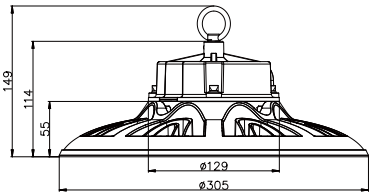

05 LGS-UFOB-300W

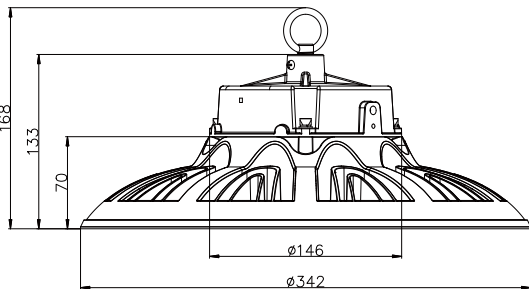

06 LGS-UFOB-400W/500W

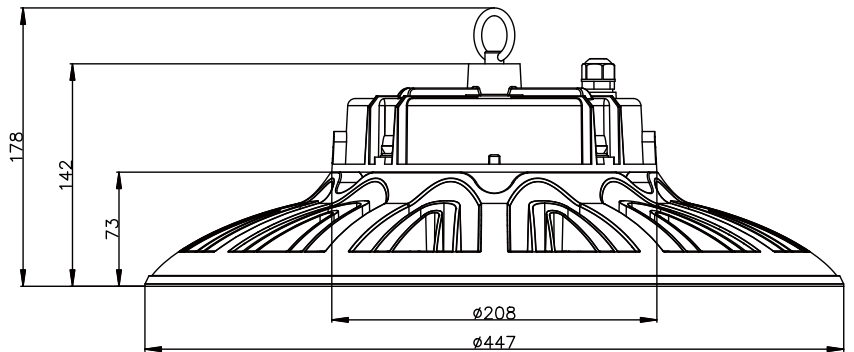

# Spare Part Options



Zhaga Socket



Microwave Sensor



Alu Reflector



U Bracket



Safety Steel Rope